

Grace系列安装说明书
Grace series installation menu



 该产品只能安装在室内环境，不能与水接触。
The LED luminaire is installed indoor not outdoor. It is not allowed to be rinsed with water.

 外置LED驱动，嵌入式安装。
Independent LED driver. The luminaire is recessed.

爱加照明科技有限公司

广东省东莞市长安镇乌沙兴发南路东三街1号
Tel: 0769-8539 7723 / 8539 7729 Fax: 0769-8258 3418
E-mail: info@vf-lighting.com Http: //www.vf-lighting.com

VF
VISUAL FEAST

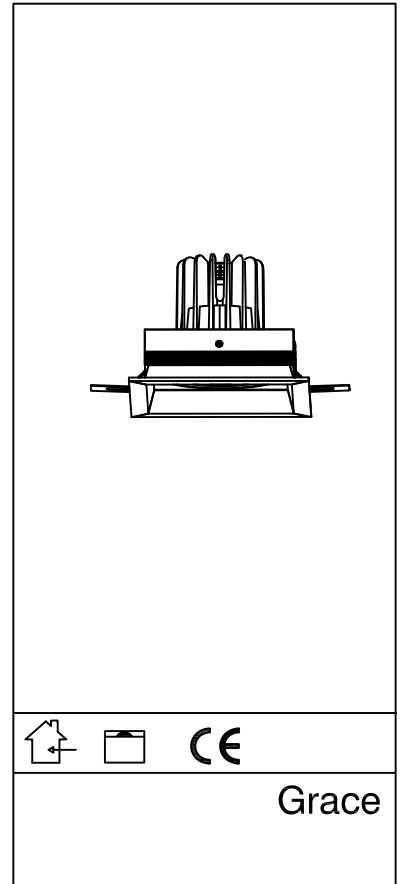

Grace系列安装说明书
Grace series installation menu

制图		名称	说明书	材质	80g双面光铜版纸
审核		零件编号	914044C	尺寸	200x220mm双面印刷
批准		版本	C版	备注	图框不做印刷使用

型号	开孔尺寸
GR8712619	105*105
GR8712629	215*105
GR8712639	325*105
GR8722613	135*135
GR8722623	280*135
GR8722615	160*160
GR8722625	330*160

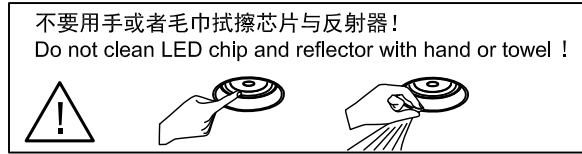

- 只能使用符合IEC或3C安全标准的电源；
- 检查电源是否匹配灯具；
- 须考虑到最大电流值；
- 灯具上显示电压不是用来选择恒压电源，而是表示所选择恒流电源所覆盖的电压；
- 采用合适的ESD措施，避免触摸裸导体；
- 若与某种化学物质或气体接触，LED芯片会受损；
- 因此不能用化学物质清理LED壳体或LED驱动灯，如下物质证实对灯具的性能有负面影响，不能与LED灯具处在同一环境下。

指甲油
超能胶水
乙二醇
甲醛
LOCTITE胶水
漂白粉，含漂白粉的清洁剂、喷雾剂
LOCTITE 384胶
LOCTITE 7387 活化剂

- 将绝缘物移开或提供足够空间以便灯具本身的温升不会超过额定的；
- LED芯片对开关瞬态很敏感，因此，LED灯具与电器必须在断电状态下连接，不可热插拔。
- VF 建议使用灯具说明书上指示的电源。
- 须顾及到产品的极性。

- Use only power suppliers which are certified according to the applicable IEC or 3C standards.
- Check the ratings of the power supply to match the luminaire.
- The maximum current rating must be taken into account.
- The indicated typical voltage must not be used to select a constant voltage power supply but is intended to be used to select a constant current power supply that is able to cover that typical voltage.
- Take appropriate ESD measures. Avoid touching bare conductor.
- LED can be damaged by the contact with certain chemicals or chemical gasses, therefore, LED luminaires or LED drivers should never be cleaned with chemical substances.
- The following substances have proven to have a negative influence on the performance and must not be used in the direct environment of led luminaire.
Methyl acetate or ethyl acetate (i.e., nail polish remover)
Cyanoacrylates (i.e., "Superglue")
Glycol ethers (including Radio Shack® Precision Electronics Cleaner - dipropylene glycol monomethyl ether)
Formaldehyde or butadiene (including Ashland PLIOBOND® adhesive)
Dymax 984-LVUF conformal coating
Loctite Sumo Glue
Gorilla Glue
Bleach, Bleach-containing cleaners, sprays
Loctite 384 adhesive
Loctite 7387 activator

- Remove insulation and/or provide sufficient ventilation so that the indicated max Tc is not surpassed.
- LED are susceptible to switching transients. Therefore It is allowed to connect the driver with the fitting while the power is off.
- VF recommends to use the power supplies that are indicated in the installation menu.
- Respect polarity
- Don't test LED luminaires one by one on a powersupply that is switched on.

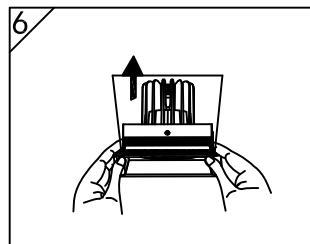
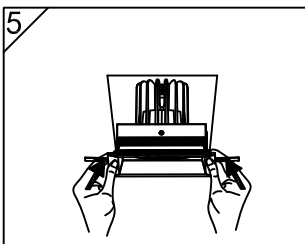
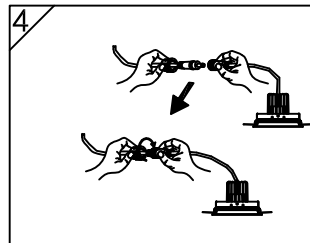
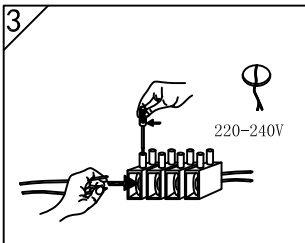
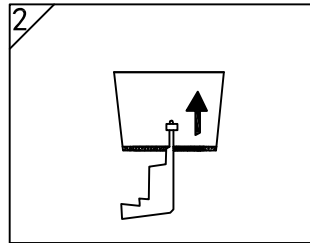
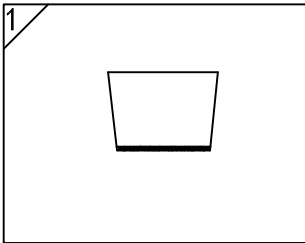

具体外观以实物为准！